

# OWNER'S MANUAL

*Herschede*<sup>®</sup>

Gold Medal winning clocks since 1885



*Herschede*<sup>®</sup>

**Owner's Manual**

Grandfather Clocks

Tubular Bell (Cable Wound)

**Read this manual in its entirety before attempting to set up your Herschede clock.**

Herschede Hall Clock Co., Starkville, Mississippi 39759

[WWW.CHAMPSCLOCK.COM](http://WWW.CHAMPSCLOCK.COM)

## Contents

<i>Introduction</i> .....	4
<i>Setting up the tubular bell clock</i> .....	6
<i>Tools for assembly</i> .....	7
<i>Unpacking</i> .....	7
<i>Installing movement</i> .....	8
<i>Hanging chime tubes</i> .....	8
<i>Leveling cabinet</i> .....	10
<i>Assembling pendulum</i> .....	10
<i>Hanging weights</i> .....	12
<i>Correct chime selector positions</i> .....	12
<i>Setting clock</i> .....	13
<i>Checking chimes</i> .....	14
<i>Setting time</i> .....	14
<i>Setting moon dial</i> .....	14
<i>Position of tubular bells</i> .....	15
<i>Regulating timekeeping</i> .....	16
<i>Care and maintenance</i> .....	16
<i>A few do's and don'ts</i> .....	16
<i>What to do if problems occur</i> .....	17
<b>CABLE SECURING BLOCKS</b> .....	PDF PAGE 19
<b>CHIME ROLLER SECURING BLOCK</b> .....	PDF PAGE 20

## Limited Warranty Herschede Clock Warranty

This Herschede clock is guaranteed against factory defects in workmanship and materials to a buyer who purchases this clock for purposes other than for resale or use in the ordinary course of the buyer's business of this consumer product. Under this warranty, any part or parts that become defective within 1 full year from registered date of purchase will be replaced or repaired without charge, excepting shipping damages, obvious misuse, and abuse. Transportation charges (if any) to be paid by owner. After 1 full year, all adjustments, oiling, and repairing, should be handled by your local clock repairman. He will make a nominal charge for repair parts and labor.

Your warranty for the purchase of this clock does not cover sources of problems that are beyond factory control and which cannot, therefore, be covered under our warranty. The items not covered are:

1. Leveling the clock after the clock has been moved by the consumer or it has "settled" in carpet.
2. Adjusting the "beat" of the clock after once being put into proper "beat" upon set-up.
3. Regulating the clock for time keeping accuracy.
4. Repairing or replacing damaged pendulum suspension springs.
5. Adjusting chime hammers or volume after being set-up upon delivery.
6. Resetting the moon dial after first set-up. (See owner's manual.)
7. Correcting any other problem caused by customer neglect, misuse, or failure to follow instructions included in the owner's manual, which accompanies this clock.

Your warranty for the purchase of a tubular bell clock (see owner's manual) is not valid unless set-up is handled by a factory authorized Herschede service station or a dealer specifically authorized by Herschede to set-up a tubular bell clock. The cost of such installation and set-up is included in the original price of the clock.

To obtain in-warranty service, contact your nearest factory authorized Herschede service station. (See list included in consumer's packet.) You should be able to furnish the service representative with date of purchase. Information provided to the service station by the consumer will enable the service representative to state whether the clock is in warranty. If malfunctioning clock is not covered in-warranty, the clock service man will charge for his service. This warranty gives you specific legal rights and you may also have other rights which vary from state to state. This warranty registration card must be mailed to the factory within 10 days of purchase for registration, with purchase date recorded, in order to obtain warranty performance.

Movement type and No. \_\_\_\_\_

Dealer's name \_\_\_\_\_

Date Purchased \_\_\_\_\_

Model No. \_\_\_\_\_

**SAMPLE**  
**ONLY - DO NOT MAIL**

If necessary, for further warranty service you may contact:  
Consumer Services - Herschede Hall Clock Company  
P.O. Box 825 - Starkville, Mississippi 39759  
A Division of Arnold Industries, Inc.

[WWW.CHAMPSCLOCK.COM](http://WWW.CHAMPSCLOCK.COM)

## Dear Herschede Clock Owner:

Congratulations!

You now own one of the world's finest chiming floor clocks. Get to know it well — you will be living together a long, long time. Given proper care and maintenance, your Herschede clock will serve you faithfully and accurately for years to come. Before long you will come to think of it not as a mere timepiece, but as a beloved companion that radiates warmth and charm throughout your home.

One of the many features that makes your clock unique is the name Herschede on the dial. This honored and tradition-rich name is the oldest in the American chiming floor clock business. We have been making gold medal winning clocks since 1885. We are, in fact, the only clock maker in America that makes its own tubular bell clock movements. We are clock makers. Not just cabinet makers.

Now, before going further, let's look briefly at the individual parts of your clock.

**The Case** Your case is, above all, a fine piece of furniture — superbly designed and hand-finished. It will become a center of interest in your home. A conversation piece that brings praise and compliments from friends and acquaintances. A symbol of your good taste. Herschede clock designs are rich in tradition, many going back to the 18th Century. With their fine propor-

tions and with the warmth and richness of their coloring and finishes, these clocks not only add magnificence to traditional settings but give modern arrangements a touch of grace and elegance.

**The Movement** Herschede is the only manufacturer in America that makes its own clock movements. With regular oiling and cleaning, this movement will perform accurately and dependably for years to come.

**The Chimes** All Herschede clocks play the Westminster chime, the most famous of chime melodies. Based on Handel's "Messiah," "I Know That My Redeemer Liveth," it was made famous in 1859 by London's fabled Big Ben. Besides Westminster, Herschede nine tubular bell clocks play the Whittington and Canterbury chimes. The latter, inspired by the grandeur of Canterbury Cathedral, was composed especially for Herschede.

### Whittington

1st Quarter. 2nd Quarter. 3rd Quarter. 4th Quarter. Hour.

"Turn again, Whittington  
Lord Mayor of Londontown."

### Canterbury

1st Quarter. 2nd Quarter. 3rd Quarter. 4th Quarter. Hour.

I'll pass this way but once, Any good that I can do, Let me know it now  
Let me not neglect it, Let me not de-fer it, For I'll not pass a-gain.

I'll pass this way but once, Any good that I can do, Let me know it now, For I'll not pass a-gain.

Copyright 1905 by The Herschede Hall Clock Co.

"I'll pass this way but once  
Any good, that I can do,  
Let me know it now  
Let me not neglect it or defer it  
For I shall not pass this way again."

### Westminster

1st Quarter. 2nd Quarter. 3rd Quarter. 4th Quarter. Hour.

"Lord, through this hour  
Be Thou our guide  
So, by Thy power  
No foot shall slide."

The tall and dignified Herschede tubular bell grandfathers have either five or nine Tubular Chimes. In addition to quarter hour chimes, all Herschede clocks have an hour strike — a deep, resonant tone that counts the passing hours.

## Setting up the tubular bell clock

Your clock has arrived in four separate boxes (A,B,C&D). Contents of each box are noted below.

### BOX A

1. Clock case
2. Door key (in small envelope attached to security pad around clock)
3. Finial (attached to side rail inside of case)

### BOX B

1. Clock movement
2. Pendulum bob
3. Lyre (Model No. 250 only)
4. Suspension spring
5. Winding key
6. Four wood screws (in small envelope atop seat board)

### BOX C

1. Chime tubes
2. Pendulum rod

### BOX D

1. Chime weight (marked CT on bottom), 20 lbs. for 5 tube models; 26 lbs. for 9 tube models
2. Time weight (marked TT on bottom), 11 lbs.
3. Strike weight (marked ST on bottom), 11 lbs.

**Check contents of boxes carefully before discarding. Some people inadvertently throw away the winding key and suspension spring with packing materials.**



## Tools for assembly

To assemble your clock, you will need the following tools and aids:

1. Wire cutters or pliers
2. Phillips screw driver
3. Spirit level
4. Pocket knife
5. Thin bladed screw driver
6. Shims (for leveling clock)
7. White cotton gloves or soft cloth (to use while handling brass parts and tubes)

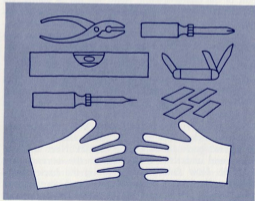

## Unpacking

Unpack Box A first. Set upright and remove packing materials (don't forget door key). To get clock case out of box, grasp left side about midway up and lift from bottom. Once case is free, set it near its *permanent* location. Turn cabinet sideways and remove back panel by loosening four phillips screws. Remove top panel in same manner.

**NOTE:** All Herschede five and nine tube clock cabinets has removable tops, whether flat or curved. Remove retaining screws and top will lift off.

Next unpack the movement (Box B). Don't forget the small package containing the bob, winding key and suspension spring. Locate and lay aside for time being.



## Installing movement

Remove protective tissue wrapping from movement, but **DO NOT** remove string holding chime hammers until movement is in case. Holding movement by the tube rack (Fig. 1), set seat board (A) on side rails (B) in cabinet. Slide movement forward until it is flush with face of cabinet. Line up clock face with opening in cabinet. Using key, open front door. Next, using a nail or long, thin object, line up screw holes in seat board and side rails. Screw seat board to side rails, using four phillips screws located in small envelope on top of seat board. Screws should be *tight*.

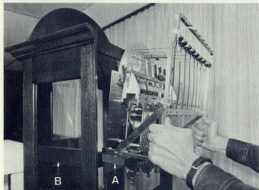

Fig. 1

## Hanging chime tubes

Open Box C containing chime tubes. A white ticket identifies the strike (hour) tube in both the five and nine tubular bell movements. The pendulum rod is taped to the side of this tube. Gently remove rod (it is very delicate) and set aside. Unwrap the plugged (solid) end of the strike tube, exposing a small brown string. (Do not unwrap rest of tube at this time. This would only expose it to fingerprints.) Insert strike tube through front of cabinet and lean against cabinet wall. Remove protective string holding hammer springs. Cut and remove *white cords only*. Do not cut black strings — they are part of the chime system. Read red tag. It warns you not to tamper with adjustment screws on hammer springs (Fig. 2). They were pre-set at the factory. You are now ready to hang the strike (hour) tube. In the *five tube movement*, the hour tube should be hung on the extreme right button, as seen from back (Fig. 3). The rest of the tubes should be hung from *right to left* (as seen from back), starting with the longest chime tube and proceeding to the shortest. In the *nine tube movement*, the hour tube hangs on the second slot of the hour tube hanger. This hanger is located on the left side of the rack (Fig. 4). Getting there with the hour tube is a little tricky. First slide the lower end of the tube to the left back corner of the cabinet. Next slide the upper end under the chime rack on the extreme right (Fig. 5). Now slide the tube along the back of the seat board to the extreme left and hang on the hour tube hanger. Hang rest of the tubes on buttons at



Fig. 2

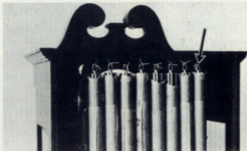

Fig. 3

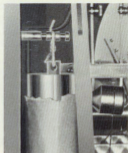

Fig. 4

back of the tube rack (Fig. 3), starting with the longest tube on the right (as seen from back) and proceeding to the shortest. See page 15 also for layout. Replace back of cabinet and position clock in *permanent* location.

Move to front of cabinet and slide wrapping material from chime tubes. Pull gently from bottom of tube and "snake" off. (NOTE: Wear white cotton gloves or use a soft cloth when handling chrome or brass parts. Moisture in your hands will tarnish metal. Wipe off fingerprints immediately if you accidentally touch something you shouldn't.)



Fig. 5

## Leveling cabinet

Place a spirit level alongside cabinet from front to back and side to side. See pictures below.

Problems can result from imperfect leveling. Check the balance periodically — especially if the clock is on carpet and may settle after original leveling.



Side to Side



Front to Back

## Assembling pendulum

Assemble pendulum (Fig. 6). Remove adjusting nut (A) from rod (B). Slide rod through bob (C), making sure polished side of bob is on same side as the beat adjustment disc (D). (NOTE: On Model No. 250 insert lyre (Fig. 7) on pendulum rod before installing bob.) Replace adjusting nut. Screw on until top of bob reaches scratch mark on back of pendulum rod. Remove suspension spring screw (E). Insert suspension spring (F) in slot (G) and replace screw. Screw should be snug but not tight. Install pendulum in clock through front door. Hang T-bar in anchor bridge (Fig. 8). Insert beat adjusting pin in anchor fork (Fig. 9).

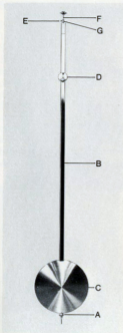

Fig. 6

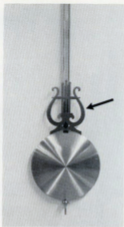

Fig. 7

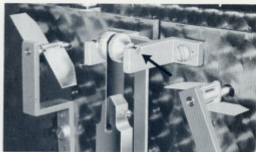

Fig. 8

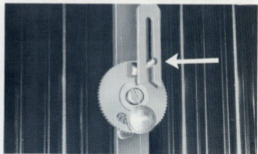

Fig. 9

## Hanging weights

Now you are ready to hang the weights. Open Box D and remove wrapping from weights (leave brown paper until weights are hung.) Hang the large weight first. It goes on the right cable (facing front of clock). Stamped CT (for Chime Train) on bottom, this weight powers the chime gears. It weighs 20 pounds in a five tube movement and 26 pounds in a nine tube movement. The other two weights weigh 11 pounds each. Hang the one stamped TT (for Time Train) in the center (it powers the pendulum) and the one stamped ST (for Strike Train) on the left (it powers the hour strike). To install weights, flip pulley (Fig. 10) and hang on stirrup. Remove brown paper. NOTE: On clocks with an electric movement, hang weight pulley cords on hooks under seat board, then hang weights on pulley. (The weights are dummies and have no actual bearing on the operation of the clock.) Plug into a standard 110 volt electrical outlet.



Fig. 10

## Correct chime selector positions

If chime selector is not correctly positioned, a malfunction or stoppage during playing of chime may occur. Do not turn chime selector lever when clock is chiming. Turn only after chimes have finished playing. Failure to do so may cause bent or broken pins on chime cylinder.

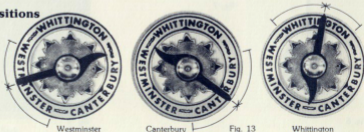

Fig. 13

## Setting clock

Push strike silent lever up to strike position (Fig. 11). Turn chime indicator counterclockwise to chime (Fig. 12). Select chime (Fig. 13). Insert winding key in arbors (Fig. 14) and wind weights until top of weights are even with top of door opening. Check cable to see that it tracks properly in the winding drum grooves (Fig. 15). Swing pendulum gently to the left and let go. Listen to the beat. It should have an even, regulated tick and swing evenly in both directions. Rarely does a tubular bell clock arrive out of beat. If it needs adjusting, however, loosen the beat adjusting nut (Fig. 16, A) and move the beat adjusting disc (B) either left or right (using trial and error method) until the beat becomes regular. Tighten nut.



Fig. 11 Shown on silent.



Fig. 12 Shown on silent.



Fig. 14

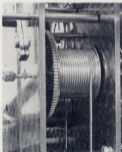

Fig. 15

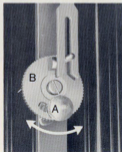

Fig. 16

## Checking chimes

Turn the minute hand clockwise to the quarter-hour. Let chime. Turn hand to half-hour (Fig. 17). Let chime. Turn hand to three-quarter hour. Let chime. Turn hand to 12 o'clock. Let chime and strike hour.

## Setting time

You are now ready to set the time. Do so by moving the minute hand clockwise (hour hand will follow). Be sure to stop at each quarter hour and let the clock go through its chime sequence. **Failure to do so could result in a broken pin inside the movement.** Caution: if clock runs down completely due to failure to wind, be sure to



Fig. 17

wind before setting hands. This allows chime to complete its cycle.

## Setting moon dial

Position moon directly beneath numeral 15. Using an almanac as your reference, count the number of days past full moon. Turn moon dial (Fig. 18) two clicks clockwise (facing dial) for every full day (24 hours) past full moon. For example, if moon is five days past full moon you would move dial 10 clicks clockwise to set.

Replace cabinet top, screw in finial and your clock is set for many years of dependable service.

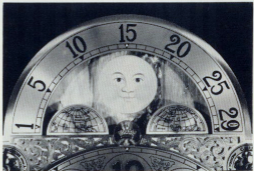

Fig. 18

## Position of tubular bells

From left to right, facing front of clock





## Regulating timekeeping

Changing the speed of timekeeping on any Herschede pendulum clock is accomplished by moving the pendulum bob up and down.

**Faster:** To speed up timekeeping, turn pendulum rating nut (Fig. 25) to right (clockwise) to raise pendulum bob.

**Slower:** To slow down timekeeping, turn pendulum rating nut (Fig. 25) to left (counter clockwise) to lower the pendulum bob.

This adjustment should be made gradually. Check timekeeping when you wind clock and make adjustment accordingly. Use the same clock or watch each time you check the clock, this will minimize error caused when using different sources of correct time.

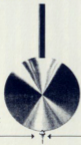

Fig. 25

Turn rating nut clockwise to speed up timekeeping

Turn rating nut counter clockwise to slow down timekeeping

## Care and maintenance

Your Herschede clock requires very little attention. There are a few things you can do, however, to increase its life considerably.

1. Wax and polish your clock cabinet as frequently as you wax and polish your other fine furniture. Any good furniture polish or paste wax will do.
2. Oil your clock every two or three years, using only good clock oil. Clean it every five to ten years depending on climate conditions. Extremely arid or salty air, heat or cold may necessitate more frequent servicing. Desert climate with high heat and low humidity causes oil to dry up. Salt air causes oil to break down. Note: Unless you are mechanically skilled, we don't recommend your attempting to clean your clock. Instead call a reputable clock service station (see list of recommended service stations in your owner's kit).

## A few do's and don'ts

DO wind your clock every seven or eight days. If weights run down and pendulum stops, wind weights partly up. Set clock, then wind weights slowly to top and gently swing pendulum.

DO hang weight marked CT (underneath the weight) on the right (facing the clock). Otherwise, clock won't operate properly.

DO see that your clock is level at all times.

DO remove key from door of grandfather clocks to prevent tampering.

DO check contents of cartons thoroughly before discarding. Otherwise, you might inadvertently throw out suspension spring and winding key with packing materials.

DO have a trained clock serviceman oil and clean your clock at recommended intervals (see *Care and maintenance*). We recommend a good synthetic clock oil such as Nye or Mobis brands.

DO allow clock to go through its chime sequence when advancing minute hand. Failure to stop at each quarter hour could result in a broken pin inside movement.

DO specify clock model and type movement (five tube or nine tube if tubular bell) if you have occasion to write the factory about a problem.

DO stop pendulum swinging when leaving for more than a week.

DON'T touch pendulum bob or weights with your bare hands. Perspiration contains acid that causes weights, shells and pendulum bob to tarnish. Wipe immediately with soft, clean cloth if touched.

Use extreme caution when cleaning glass inside clock. Spray the cleaner on cloth and then wipe glass. Do not spray directly into cabinet. Also, do not spray move-

ment with any type of lubricant, as this will void your warranty.

DON'T locate clock near heating or air conditioning vents. Excessive humidity could affect cabinet or movement.

### **What to do if problems occur**

Your Herschede clock should repay you with accurate timekeeping if it receives regular maintenance.

Should you ever encounter difficulty in regulating your clock or have trouble with the movement, be sure to contact an Authorized Herschede Service Station as soon as possible.

This clock is equipped with our new Cable-Pulley Blocking System. Follow these instructions carefully to remove blocks.

*Herschede*<sup>®</sup>

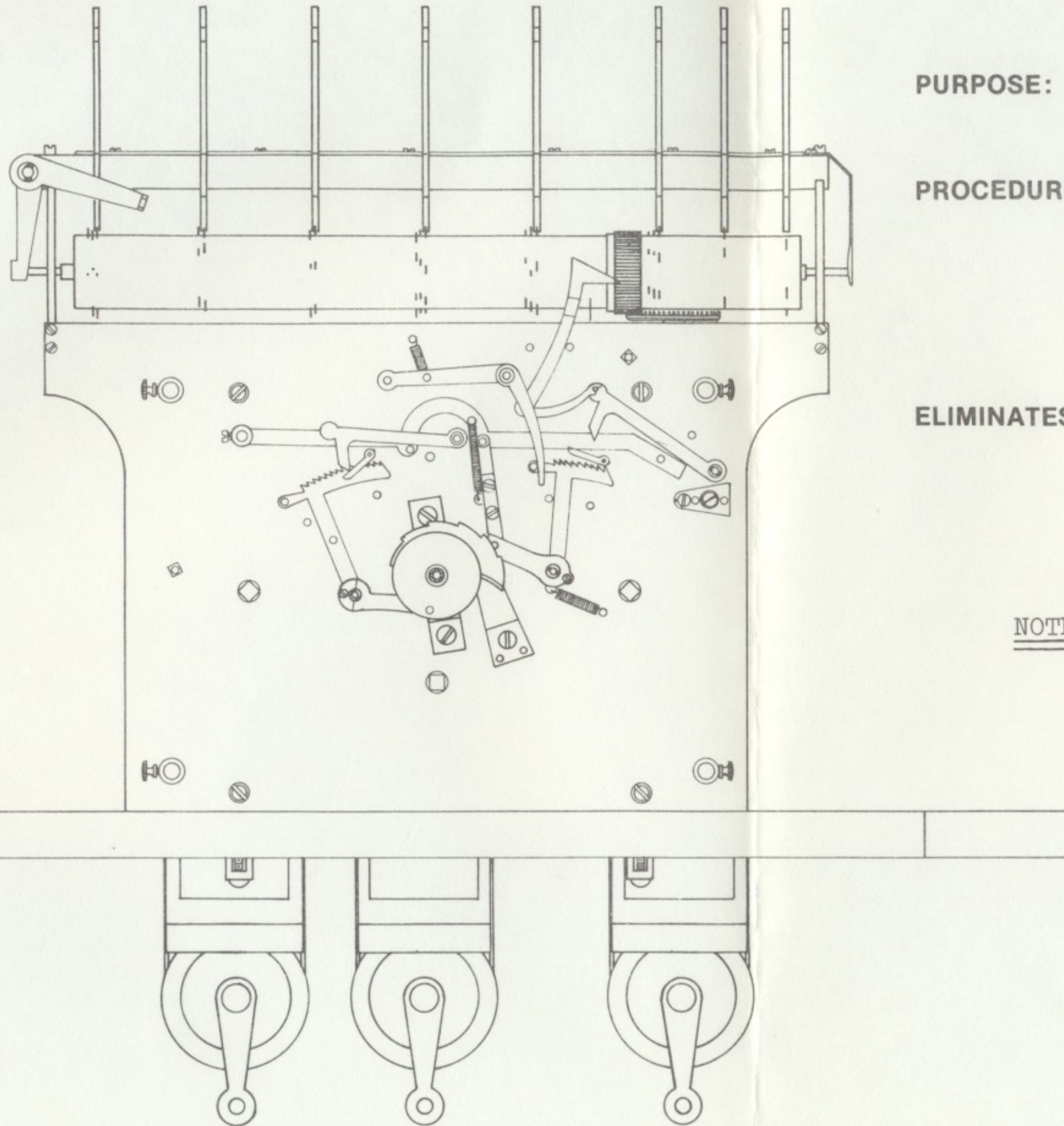

**PURPOSE:** To secure cable pulley up against seat board preventing loose and tangled cable. This will simplify handling and prevent damaged cable.

**PROCEDURE:** After movement is secure in case and leaving blocks installed, follow normal set up procedure (refer to pages 6-15 in owner's manual). In normal running of clock with pendulum on, it must run 4 to 5 hours before blocks can be removed. After allotted running period, simply lift blocks off of pulley and save for future use.

**ELIMINATES:** The waiting period to let clock run down completely before being able to remove weights to move clock, or having to release the main wheels to untangle weight cables when weights have been removed before they were down completely.

NOTE: If center block is not removed within 4 to 5 hours it may cause clock to stop running (beat pin may hit back of center block).

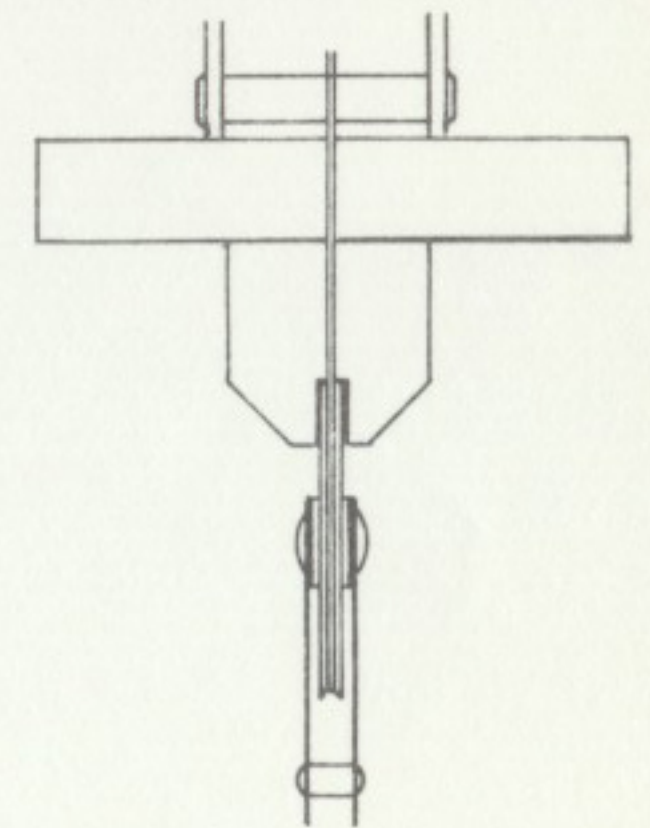

SIDE VIEW

**IMPORTANT:** DO NOT REMOVE WEIGHTS UNLESS BLOCKS ARE SECURED.  
DOING SO WILL CAUSE TANGLING OF CABLES ON WINDING DRUM AND ARBOR.

[WWW.CHAMPSCLOCK.COM](http://WWW.CHAMPSCLOCK.COM)

This clock is equipped with our new Chime Cylinder Shipping Block. Follow these instructions carefully to remove block.

*Herschede*<sup>®</sup>

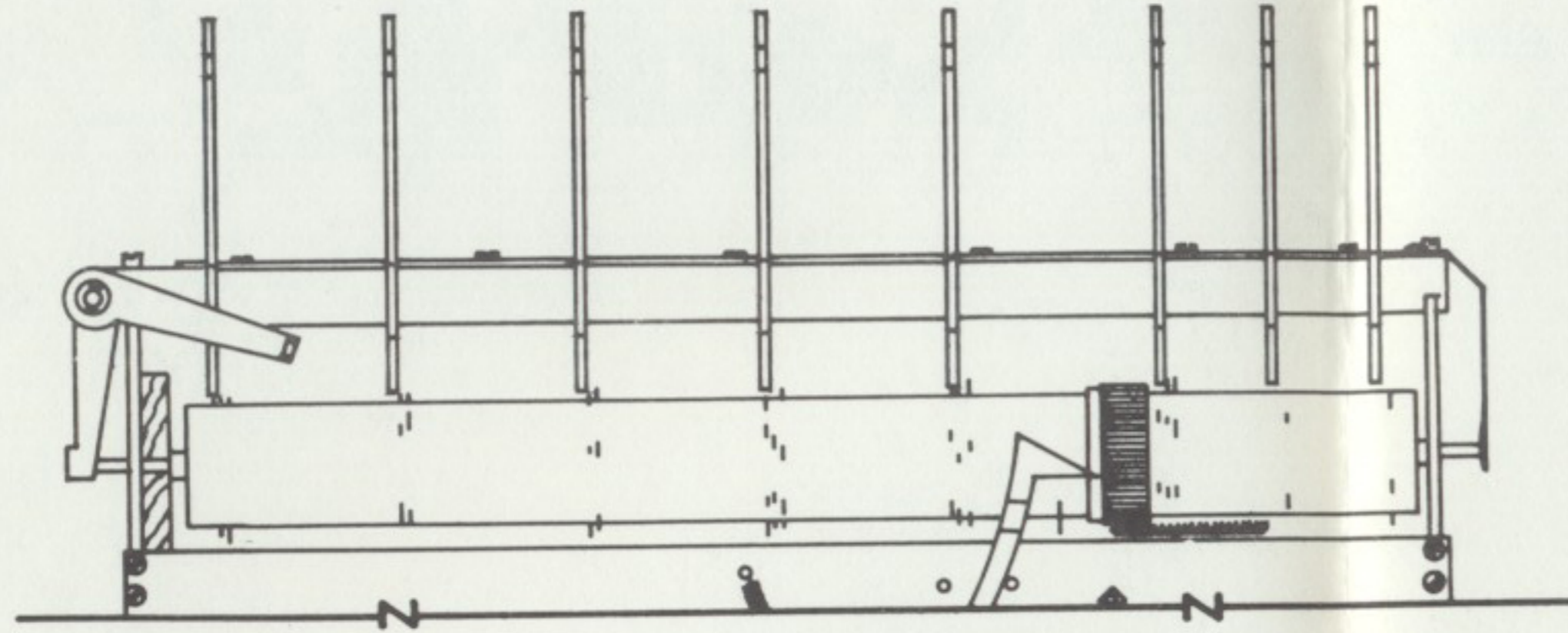

**PURPOSE:** To prevent damage to the Chime Cylinder, Pins, Shift Lever, etc.

**PROCEDURE:** After movement is secure in case, follow normal set up procedure. (Refer to page 6-15 in Owners Manual)  
Remove rubber band that secures block and remove block.

**NOTE:** If shipping block is not removed the Chime Cylinder can not be shifted and will not work properly.

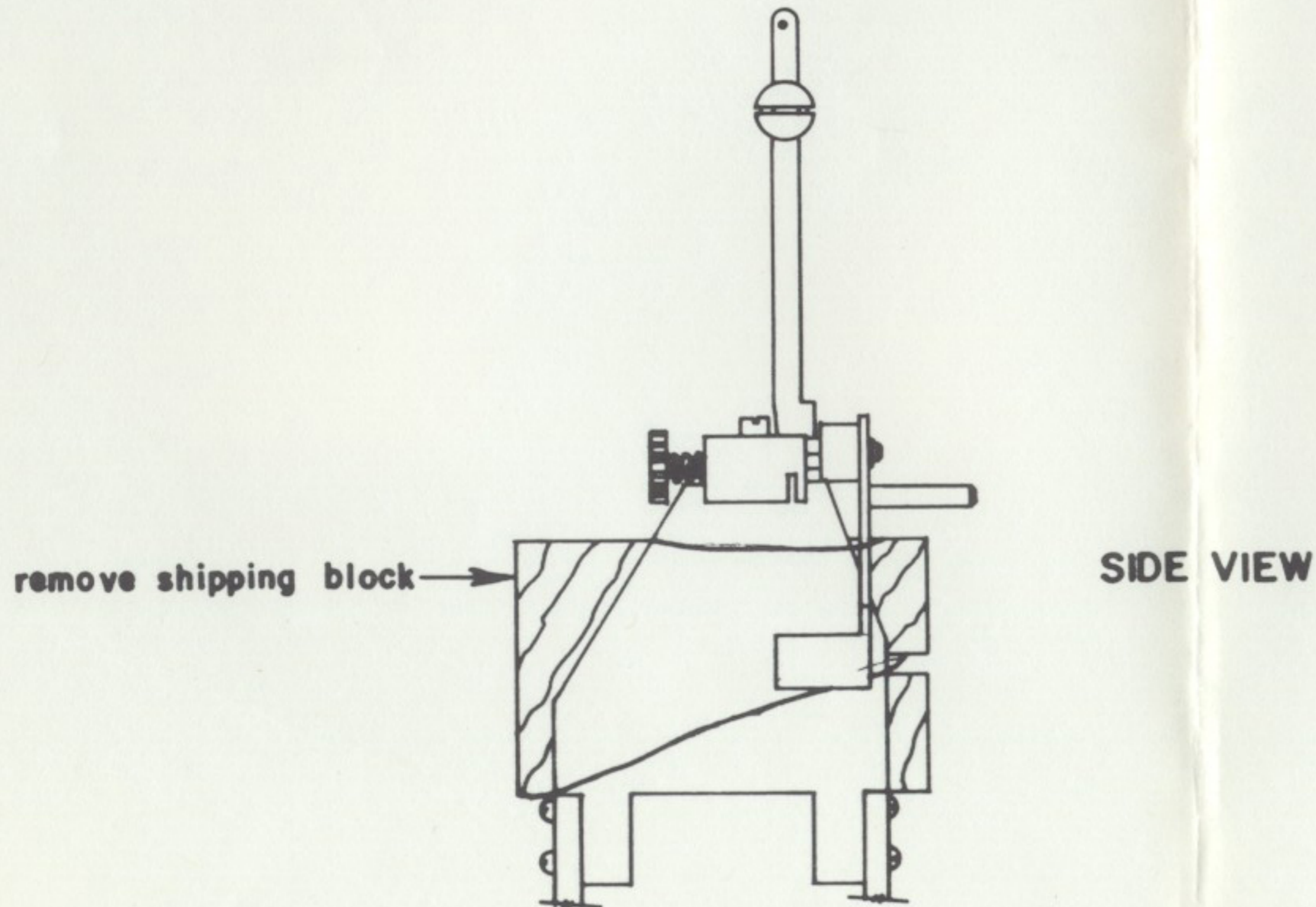

*Herschede*<sup>®</sup>

*Herschede Hall Clock Company  
P. O. Box 825, Starkville, Mississippi 39759  
Telephone: (601) 323-1521 Cable: Herschede  
Division of Arnold Industries, Inc.*

[WWW.CHAMPSCLOCK.COM](http://WWW.CHAMPSCLOCK.COM)